

Data Sheet



Article number: 339703380000

Description: Multibeam 6 Coupling 703.38.0000
St. steel & clamp hubs

Measures

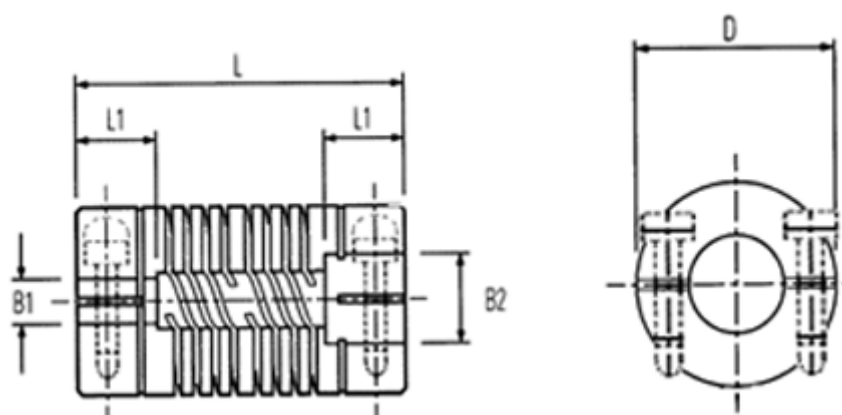

B2: Pre-drilled	= 8.0
B2: Pre-drilled	= 12.00
Cap screw	= M5
D	= 38.1
L	= 66.7
L1	= 18.0
Max angular displacement	= 0.60
Max B1 & B2	= 19.00

Max parallel displacement	= 7
Peak Torque NM	= 36.00